

523i

Zickzack Langarmnämaschine

Zickzack Säulennämaschine

524i

MAßGESCHNEIDERT FÜR IHRE ANWENDUNGEN

Long arm zigzag machines

525i

Post bed zigzag machines

CUSTOMIZED FOR YOUR APPLICATIONS

527i

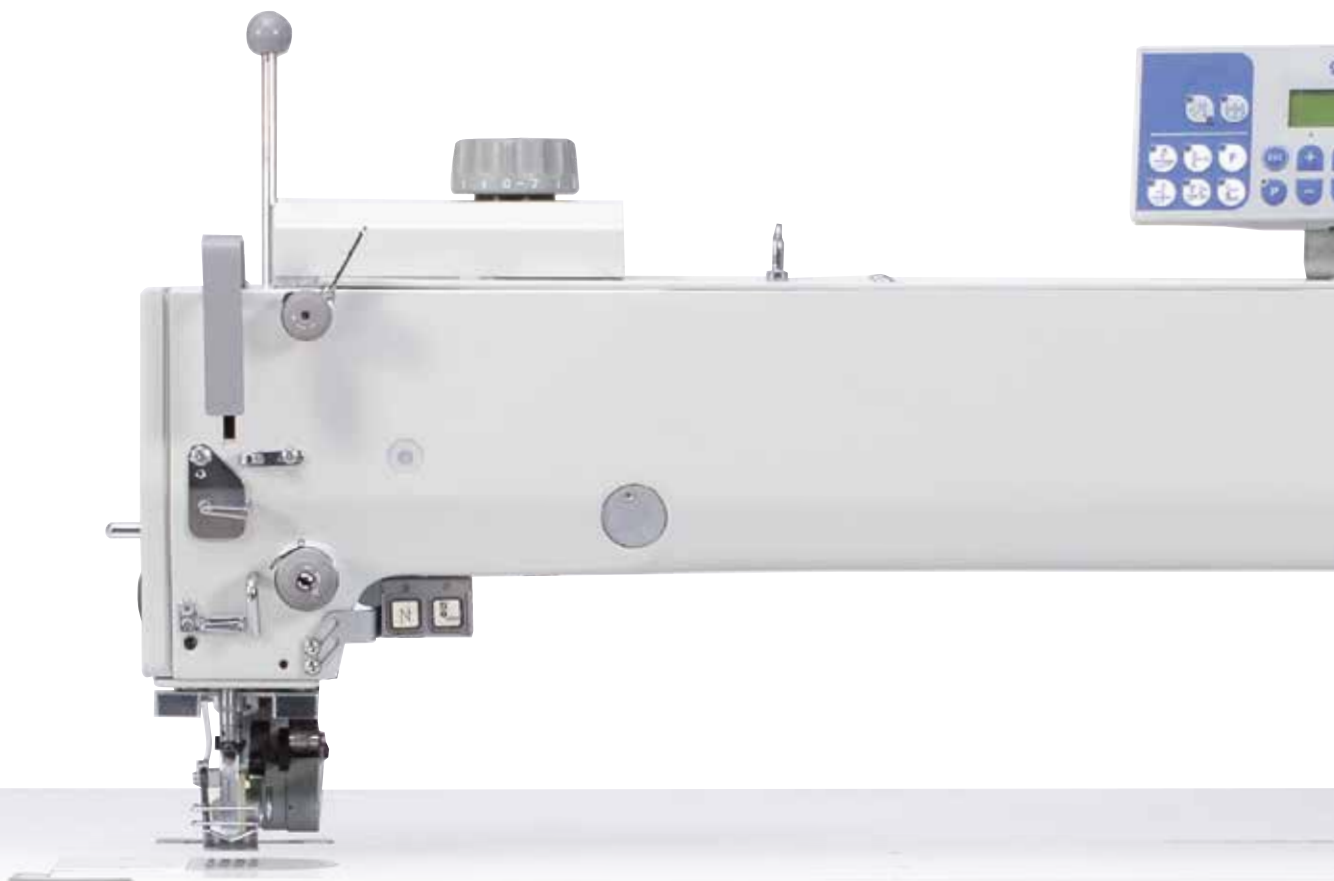

Unsere Standard-Zickzackmaschinen sind in unterschiedlichen Längen für alle anfallenden Arbeiten bei leichten bis mittelschweren Materialien verfügbar. So ist eine optimale Anpassung unserer bewährten Nähtechnologie für alle Anwendungen bei großflächigen Nähgutteilen gewährleistet.

Zickzack Nähmaschinen werden auch als Säulenmaschine angeboten. Kunden können zwischen verschiedenen Säulenhöhen wählen, um den Nähaufgaben gerecht werden zu können.

Allgemeine Vorteile

- Der Fadenabschneider (CLASSIC) garantiert ein sicheres Abschneiden des Fadens, auch für dicke Fäden bis 20/3
- Eine verbesserte Schmierung und ein Reservebehälter im Maschinenarm reduzieren den Wartungsaufwand, garantieren die korrekte Dosierung der Schmierung und schützen den Greifer vor Verschleiß
- Optimiertes Fadenabschneidesystem mit einstellbarer Spulenbremsfeder (Version CLASSIC) für bessere Nähergebnisse
- Regulierung der Nadelfadenspannung für eine noch präzisere Spannungseinstellung
- Ergonomischer Spuler mit leichter Einstellung des Maximalwertes
- Verbesserte Arbeitsbedingungen für die Bedienperson durch einen niedrigeren Geräuschpegel und weniger Vibrationen
- Neue Zickzack-Einstellvorrichtung – leichte Einstellung der Überstichbreite mit geringer Kraft
- Einfache Einstellung der Stichlänge – Einstellung ohne Hebel mittels Drehknopf
- Nahtverriegelung und Einstellung der Nadelposition hoch/tief mittels Druckknopf (CLASSIC)
- Verwendung eines eingebauten Minimotors und schnelle Verbindung zwischen Kopf und Motor (CLASSIC)
- Integrierte LED Nähleuchte (optional)

Zickzack Langarmnähmaschine

- Verschiedene Armlängen verfügbar
- Die Maschinen können mit mechanisch oder pneumatisch angetriebener Walze ausgestattet werden (optional)
- Pneumatisch betriebene Nahtverriegelung + Fußlüftung (optional)
- Vorrichtung zur Nadelkühlung (optional)
- Durchgangsraum kann auf 183 mm erhöht werden (optional)
- Extra schweres Gestell + Tischplatte erhältlich (optional)

Zickzack Säulennähmaschine

- Als ECO Version erhältlich
- Mit verschiedenen Säulenhöhen
- Version mit elektronischem Motor zur Nadelpositionierung

Our standard zigzag machines are available in different lengths for light / medium weight applications. This ensures adaptation of our proven sewing technology for applications on large-sized workpieces.

Zigzag machines are also available with posts. Customers may choose between various post heights to fulfil the desired sewing operations adequately.

General advantages

- Thread trimmer (CLASSIC) ensures secured cutting, also for thick threads up to 20/3
- Modified lubrication and a reservoir in the machine arm reduce maintenance, guarantee the correct lubrication doses and protect the hook against wear.
- Optimized thread trimming system with adjustable bobbin break spring (CLASSIC version) for better stitching results
- Needle thread tension regulation for more precise tension adjustment
- Ergonomic bobbin winder with easier adjustment of max. value
- Improved working conditions for the operator by reduced noise level and less vibrations
- Modern zigzag setting device – easy adjustment of zigzag width with low force
- Easy stitch length setting – adjustment without lever by turn button
- Back tacking and needle position up/down via push buttons (CLASSIC)
- Use of incorporated mini motor and quick connection from the head to the motor (CLASSIC)
- Integrated LED sewing light (optional)

Long arm zig zag machines

- Various arm lengths available
- Machines can be equipped with mechanically, or pneumatically driven puller (optional)
- Backtacking and foot lifting, pneumatically driven (optional)
- Needle cooling device (optional)
- Arm clearance can be increased to 183 mm (optional)
- Extra heavy stand + table top available (optional)

Post bed zig zag machines

- Available as ECO version
- With various heights of post
- Version with electronic motor for needle positioning

523i / 524i / 525i / 527i CLASSIC

Langarmmaschine / Anwendungen / Long arm machine / applications

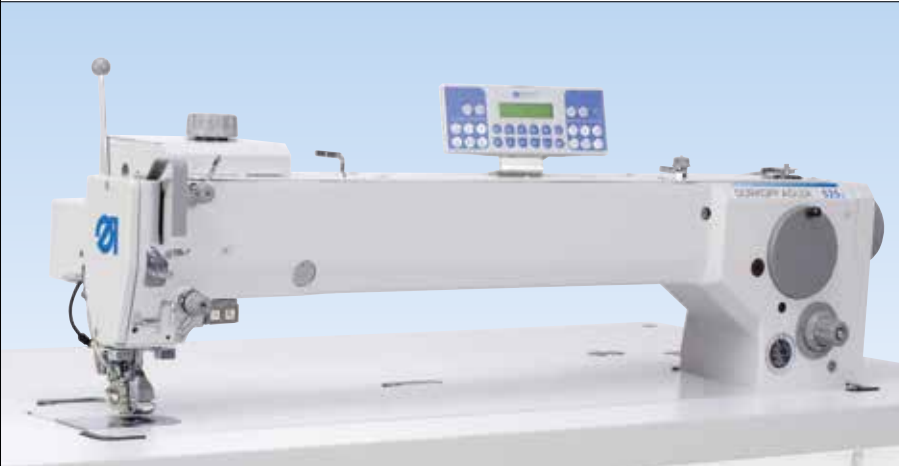

Alle Zickzack Nähmaschinen der Firma Dürkopp Adler sind als Langarmversion erhältlich.

All types of Dürkopp Adler zigzag sewing machines are available as long arm machines.

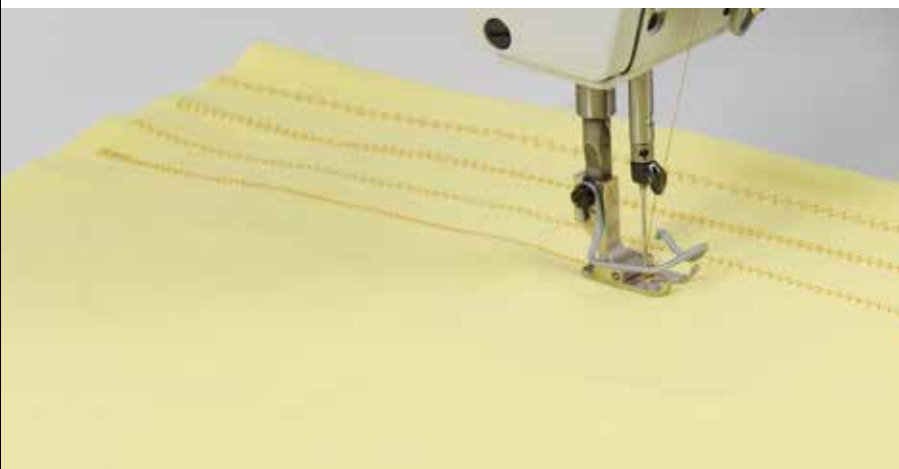

Die Maschinen werden für die Herstellung und Reparatur von großflächigem Nähgut, wie Surfsegeln, Neoprenanzügen, Zelten, Sonnensegeln etc. verwendet.

These machines are used for manufacturing and repairing large dimensioned workpieces, such as windsurfing sails, wetsuits, tents, awnings etc.



Als optionales Zubehör ermöglicht eine intermittierende Walze eine erhöhte Leistung. Diese Transporthilfe hilft, von oben eine Verschiebung des zu nähenden Materials zu verhindern. Die Walze ist mit unterschiedlich breiten Schiebrädern erhältlich.

An intermittent puller, as optional equipment, allows a high performance. The feeding assistance from above avoids material shifting. Puller is available with different widths of feeding wheel.









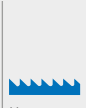
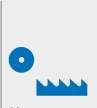

Einfache Bedienung für Nahtverriegelung und Walzenlüftung mittels ergonomischem Druckknopf.

Easy operating of backtacking and puller lifting by means of ergonomically designed push buttons.





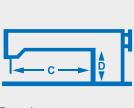





523i / 524i / 525i / 527i ECO / CLASSIC

Technischen Daten / Technical data

	 Untertransport <i>Bottom feed</i>	 Untertransport und Walzen-Obertransport <i>Bottom feed and top puller feed</i>	 Stichlänge Vorwärts + Rückwärts <i>Stitch length Forwards + backwards</i>	 Stiche/Min. <i>Stitches/min.</i>	Nähgut <i>Material</i>	 Übersichtsbreite <i>Throw width</i>	 Eine Nadel <i>Single needle</i>	 Zwei Nadeln <i>Two needles</i>	 Nadelabstand <i>Needle distance</i>	 Fadenabschneider unter der Stichplatte Nur Langarmmaschine <i>Underbed thread trimmer Long arm machines only</i>	 Säulen-Nähmaschine <i>Post bed sewing machine</i>	 Durchgangsraum C = ... mm, D = ... mm <i>Clearance C = ... mm, D = ... mm</i>
523i-411	●	○	5,0	2.500	L, M	6,0	●				○	
523i-447	●	○	5,0	2.500	L, M	6,0	●			●	○	1.050 183
524i-811	●	○	5,0	2.500	M, MS	10,0	●				○	
524i-847	●	○	5,0	2.500	M, MS	10,0	●			●	○	1.050 183
525i-811	●	○	5,0	2.500	L, M	10,0	●	○	3, 4, 5		○	
525i-847	●	○	5,0	2.500	L, M	10,0	●	○	3, 4, 5	●	○	1.050 183
525i-847-75	●	○	5,0	2.500	L, M	10,0	●	○	3, 4, 5	●		750 117
525i-847-75-66	●	○	5,0	2.500	L, M	10,0	●	○	3, 4, 5	●		750 183
527i-811	●	○	5,0	2.000	M, MS	10,0	●	○	3, 4, 5		○	
527i-847	●	○	5,0	2.000	M, MS	10,0	●	○	3, 4, 5	●	○	1.050 183

○ = Zusatzausstattung
● = Serienausstattung
L = Leichtes Nähgut
M = Mittelschweres Nähgut
MS = Mittelschweres bis schweres Nähgut

○ = Optional equipment
● = Standard equipment
L = Light weight material
M = Medium weight material
MS = Medium weight to heavy weight material

	 Horizontalgreifer, querstehend, klein <i>Horizontal hook, transversal, small</i>	 Horizontalgreifer, querstehend, groß <i>Horizontal hook, transversal, large</i>	 Nadelsystem <i>Needle system</i>	 Nadelstärke <i>Needle size</i>	 Durchgang beim Lüften <i>Clearance when lifting</i>	 Nähfußlüftung, automatisch <i>Sewing foot lift, automatic</i>	 Nahtverriegelung, automatisch <i>Seam back-tacking, automatic</i>	 Nahtverriegelung, handbetätigt <i>Seam back-tacking, actuated by hand</i>	 Garne: Arten u. Dicken Synthetik <i>Threads: Types and thicknesses Synthetic</i>	 Garne: Arten u. Dicken Baumwolle <i>Threads: Types and thicknesses Cotton</i>
523i-411	●		134	80 - 110	12,0	○	○	●	20/3	30/3
523i-447	●		134	80 - 110	12,0	●	●	●	20/3	30/3
524i-811		●	134	80 - 110	12,0	○	○	●	20/3	30/3
524i-847		●	134	80 - 110	12,0	●	●	●	20/3	30/3
525i-811		●	134	80 - 130	12,0	○	○	●	20/3	30/3
525i-847		●	134	80 - 130	12,0	●	●	●	20/3	30/3
525i-847-75		●	134	80 - 130	12,0	●	●	●	20/3	30/3
525i-847-75-66		●	134	80 - 130	12,0	●	●	●	20/3	30/3
527i-811		●	134-35	110 - 160	12,0	○	○	●	10/3	20/3
527i-847		●	134-35	110 - 160	12,0	●	●	●	10/3	20/3

Zickzack / Zigzag	Nennspannung <i>Nominal voltage</i> [V], [Hz]	Leistungsaufnahme <i>Power consumption</i> [kVA]	Gewicht, Oberteil <i>Weight, sewing head</i> [kg]	Gewicht, komplett <i>Weight, complete</i> [kg]	Abmessungen (Länge, Breite, Höhe) <i>Dimensions (Length, Width, Height)</i> [mm]
Langarm / Long arm	1x230 V, 50/60 Hz	0,8 (max.)	70	135/140	1.700 830 1.700
Säule / Post bed	1x230 V, 50/60 Hz	0,8 (max.)	64	120	1.060 500 1.700

523i / 524i / 525i / 527i

Zickzack Säulenmaschine / Anwendungen / *Post bed zigzag machine / applications*

**DÜRKOPP
ADLER**



Zickzack Säulenmaschine, verfügbar mit Säulenhöhen von 188 mm oder 294 mm.

Post bed zigzag machine, available with post heights of 188 mm or 294 mm.



Säulenabmessungen 67 x 54 mm.

Dimensions of post are 67 x 54 mm.



Die Maschine findet hauptsächlich in der Schuhindustrie für das Zusammennähen von großen Schuhen und Stiefeln Verwendung.

Einfaches Nähen von Futterstoff und Oberleder.

This machine is mostly used in the shoe industry, for joining operations on large-sized shoes and boots. Lining materials, as well as upper leather, are sewn easily.

MINERVA BOSKOVICE, a.s.

Member of Dürkopp Adler Group

Sokolská 1318/60

CZ-680 01 Boskovice

Phone +420 516 494 211

E-mail sales@minerva-boskovice.com

www.minerva-boskovice.com

